







36 425 977



- Roseta Ø 175 mm
- Maneta acanalada con tope de seguridad en 38°C
- Limitación de agua caliente, preajustable

	Cromo	36 425 977-00
	Platino cepillado	36 425 977-06
	Platino	36 425 977-08
	Latón (Oro 23k)	36 425 977-09
	Latón cepillado (Oro 23k)	36 425 977-28
	Dark Platinum cepillado	36 425 977-99

Complementos necesarios



Termostato empotrado con bloqueo previo - 35 426 970 90

- Profundidad de montaje mín. 80 mm
- Profundidad de montaje máx. 136 mm

Complementos necesarios



Termostato empotrado - 35 425 970 90

- Profundidad de montaje mín. 80 mm
- Profundidad de montaje máx. 136 mm

Complementos recomendados



xGRID Juego de fijación para integración en obra en seco - 12 340 970 90

Complementos necesarios



xGRID Carril de montaje 555 mm - 12 360 970 90

36 425 977

mm [inches]



Diagrama de flujo



Certificado

LGA_19385.

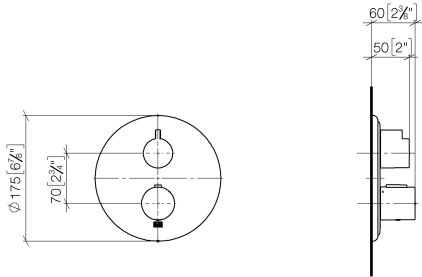
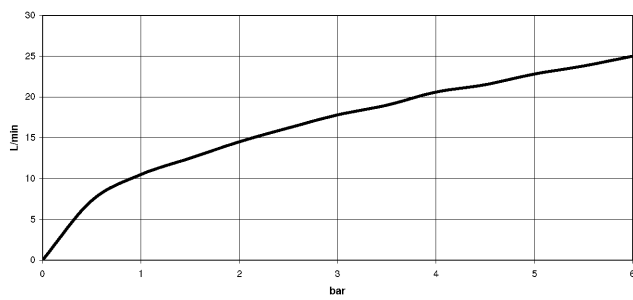
ETA_20551.

DVGW_DW-
6512DN0119.

LGA_19384.

WRAS_1906098.

36 425 977

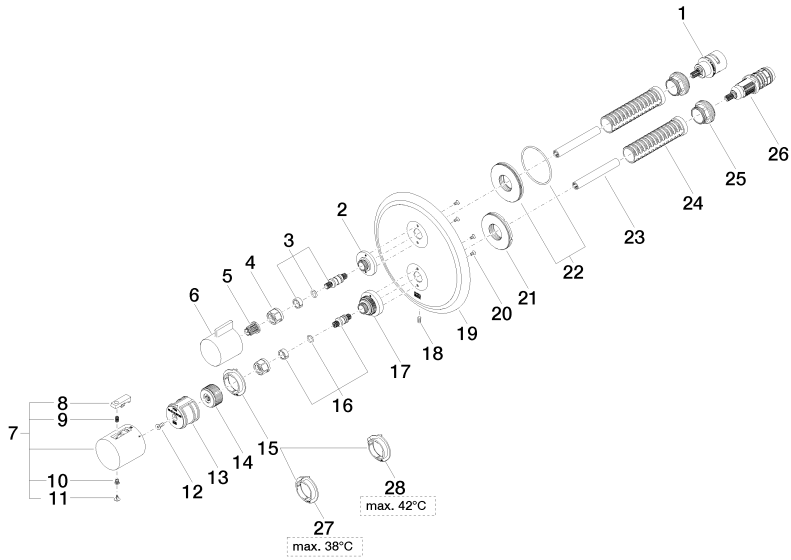

36 425 977

Lista de piezas de recambios

N°	Número de artículo	Denominación	Cantidad de montaje	Plazo de entrega
1	90 90 03 166 00 90	parte superior	1	2
2	09 12 12 053-00	alojamiento	1	10
3	04 29 06 111 01-00	husillo	1	10
4	90 23 30 023 00 90	tuerca	2	2
5	90 12 12 002 00 90	manguito de engaste	1	2
6	09 20 67 006-00	manilla	1	10
7	90 17 33 004 00-00	manilla	1	10
8	90 21 33 011 00-13	manilla	1	2
9	90 16 02 027 00 90	resorte	1	2
10	90 30 30 136 00 90	tornillo	1	2
11	90 31 20 049 00-00	tapón	1	10
12	90 30 30 124 00 90	tornillo	1	2
13	90 12 12 052 00 90	alojamiento	1	2
14	09 12 12 054 90	alojamiento	1	2
15	09 28 10 187 90	regulador	1	2
16	04 29 06 024 01-00	husillo	1	10
17	09 12 12 051-00	alojamiento	1	10
18	09 31 11 134 90	varilla	1	2
19	09 11 02 307-00	placa	1	60
20	09 30 30 157 90	tornillo	4	2
21	09 30 01 296 90	disco	1	2
22	90 30 01 190 00 90	disco	1	2
23	90 23 01 124 00 90	camisa	2	2
24	90 18 40 077 01 90	husillo	2	2
25	09 24 04 257 90	tuerca	2	2
26	90 15 02 013 00 90	cartucho	1	2
27	09 28 10 188 90	regulador	1	2
28	09 28 10 189 90	regulador	1	2